

# UK Range UKX 612 Specifications

- **Unique profile and corner radii.** Sink lies flat on worktop and cloths will not snag on corners
- **Modern functional design**
- **Extra large multi-purpose bowl**
- **45mm Waste with plug and chain**
- **Waste at rear of bowl** leaves more room in cabinet space
- **Fits into a 500mm cabinet**

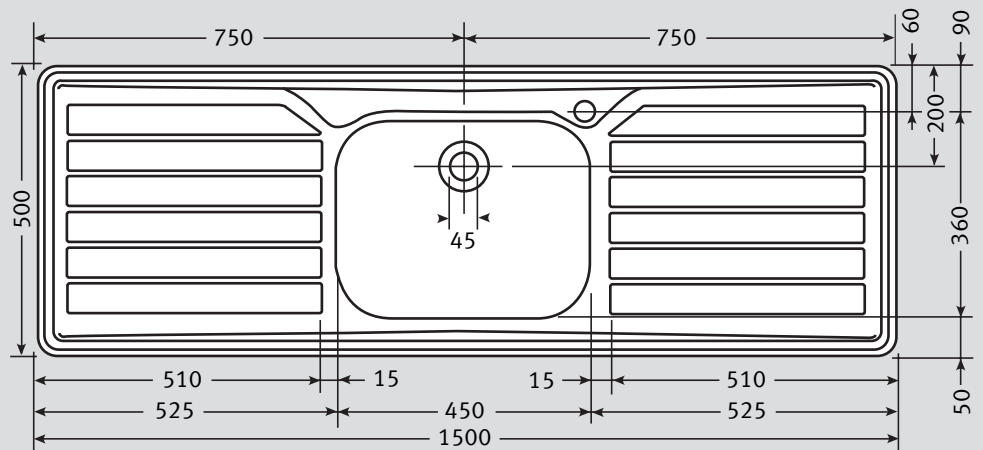
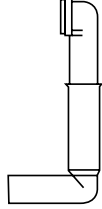
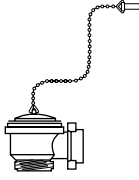
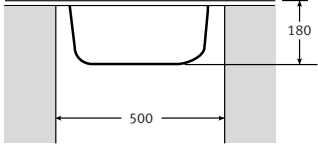
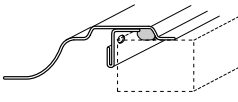
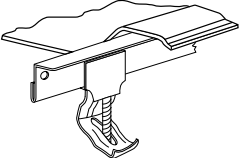
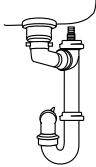

<b>Material:</b>	Stainless Steel	<b>Waste:</b>	1 x Lira 45mm Waste with plug and chain	<b>Overflow:</b>	
<b>Application:</b>	Inset or undermount				
<b>Bowl size:</b>	450 x 360 x 180				
<b>Drainer Format:</b>	Not applicable				
<b>Cut-out size:</b>	1484 x 484 (cr=20)				
<b>Colour:</b>	Silk Stainless Steel	<b>Accessories:</b>	None available		
<b>Seal:</b>	Factory Fitted Polyurethane Seal				
<b>Insulation:</b>	Grey Dynaphon for heat and sound				
<b>Heat Resistance:</b>	Up to 300°C				
<b>Earthing Point:</b>	Located at end of clip rail				
<b>Cabinet size:</b>					
<b>Sink Profile:</b> Double Edge		<b>Fixing Clips:</b> 'S' rail			
<b>Suggested Plumbing Kit:</b> 1 part					
		<b>Taps:</b> Any Franke tap can be utilised with this model.*			
		*Ceramic disc taps in certain installations or where there is a low head of water (below 4 metres) may not provide adequate flow rates. You are advised to check with your supplier.			
		Some taps may need bracing to avoid flexing of the sink ledge.			

**Guarantee:** Franke sinks are guaranteed for 25 years against manufacturing defect. Franke taps are guaranteed against defective materials and workmanship for 1 year in relation to coatings and finishes, and 5 years in relation to moving parts. Franke will replace (and where appropriate repair) defective sinks. In relation to taps, Franke will where appropriate provide replacement parts for your taps or replace your taps. Any associated or ancillary costs to be incurred by you as a result of replacement of Franke sinks and taps under this guarantee shall in all cases be previously approved by Franke UK Limited. This guarantee is in addition to and does not affect your statutory rights.