

Opera OPX 651 Specifications

- Pleasing aesthetic design
- Large Bowl Configurations
- Deep recessed drainer
- Good fall for draining
- Wide unit
- Available as Designer Pack

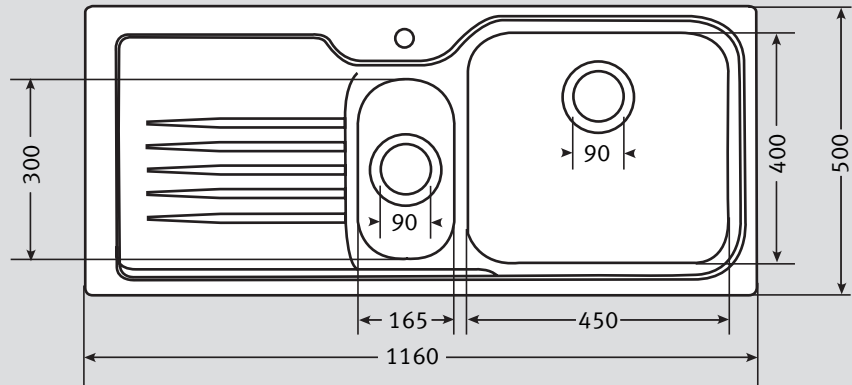

Material:	Stainless Steel
Application:	Inset
Bowl size:	450 x 400 x 190 165 x 300 x 130
Drainer Format:	Left or right hand drainer available
Cut-out size:	1144 x 484 (cr=20)
Colour:	Silk Stainless Steel
Seal:	Sealant strip provided in fixing kit
Insulation:	Sound pads
Heat Resistance:	Up to 300°C
Earthing Point:	Utilise clip point on frame

Waste: 1 x Fisc 90mm Basket Strainer Waste with overflow
1 x Fisc 90mm Basket Strainer Wastes

Overflow:

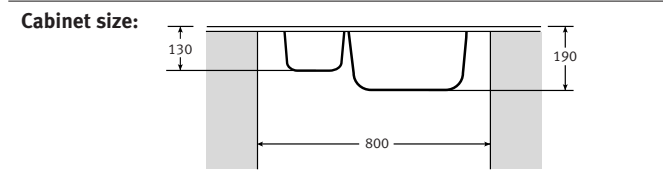
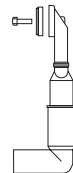
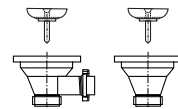

Accessories available:



Strainer Bowl
Stainless Steel

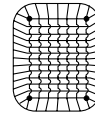

Drainer Basket
Stainless Steel



Food Preparation Platter
Mahogany

Sink Profile: Pressed Edge



Fixing Clips: 'S' rail

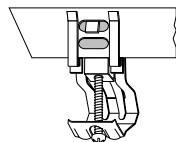

Suggested Plumbing Kit: 2 part

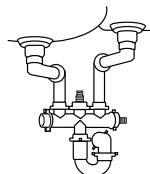

Taps: Any Franke tap can be utilised with this model*.

*Ceramic disc taps in certain installations or where there is a low head of water (below 4 metres) may not provide adequate flow rates. You are advised to check with your supplier.

Guarantee: Franke sinks are guaranteed for 25 years against manufacturing defect. Franke taps are guaranteed against defective materials and workmanship for 1 year in relation to coatings and finishes, and 5 years in relation to moving parts. Franke will replace (and where appropriate repair) defective sinks. In relation to taps, Franke will where appropriate provide replacement parts for your taps or replace your taps. Any associated or ancillary costs to be incurred by you as a result of replacement of Franke sinks and taps under this guarantee shall in all cases be previously approved by Franke UK Limited.

This guarantee is in addition to and does not affect your statutory rights.