

Nautilus NTX 651 Specifications

- Traditional Ariane design bowl
- 2 x 90mm wastes with Basket Strainer Wastes. Capable of adaptation to take Waste Disposal Unit
- Stainless Steel accessories available
- Unique large recessed drainer design
- Glide and slide accessories
- Food preparation friendly

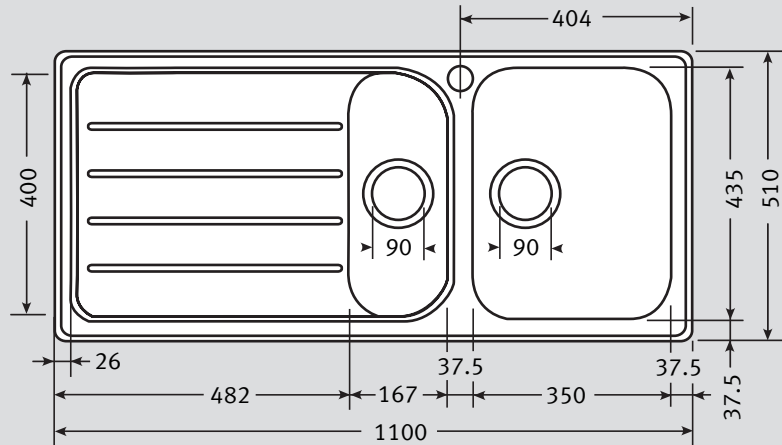

Material:	Stainless Steel
Application:	Inset
Bowl size:	350 x 435 x 180 167 x 400 x 80
Drainer Format:	Left or right hand drainer available
Cut-out size:	1083 x 493 (cr=22)
Colour:	Silk Stainless Steel
Seal:	Polyurethane Seal
Insulation:	Black Pads
Heat Resistance:	Up to 300°C
Earthing Point:	Supplied with sink

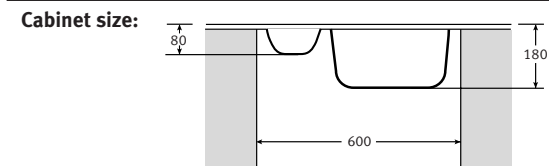

Fixing Clips: Double Edge

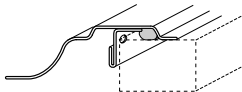

Fixing Clips: 'S' rail

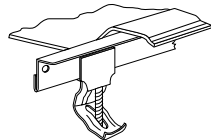

Suggested Plumbing Kit: 2 part

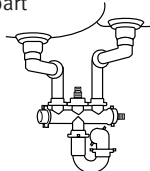

Waste: 1 x Lira 90mm Basket Strainer Waste with overflow
1 x Lira 90mm Basket Strainer Waste

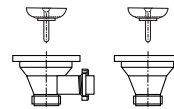

Overflow:

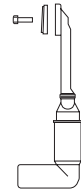

Accessories available:

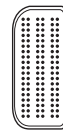

Strainer Bowl
Stainless Steel



Tray
Stainless Steel

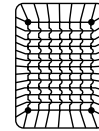

Drainer Basket
Stainless Steel

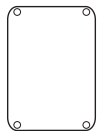

Food Preparation Platter
Kambala

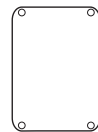

Food Preparation Platter
Glass

Taps: Any Franke tap can be utilised with this model*.

*Ceramic disc taps in certain installations or where there is a low head of water (below 4 metres) may not provide adequate flow rates. You are advised to check with your supplier.

Guarantee: Franke sinks are guaranteed for 25 years against manufacturing defect. Franke taps are guaranteed against defective materials and workmanship for 1 year in relation to coatings and finishes, and 5 years in relation to moving parts. Franke will replace (and where appropriate repair) defective sinks. In relation to taps, Franke will where appropriate provide replacement parts for your taps or replace your taps. Any associated or ancillary costs to be incurred by you as a result of replacement of Franke sinks and taps under this guarantee shall in all cases be previously approved by Franke UK Limited.

This guarantee is in addition to and does not affect your statutory rights.