

Laser LSX 611 Specifications

- Unique Slimfix fitting system
- Thin edge profile
- Ease of installation
- Modern sleek design
- Deep recessed drainer
- Jumbo bowl
- 1 x 90mm Waste with Basket Strainer Waste. Capable of adaptation to take Waste Disposal Unit
- Bespoke accessory available

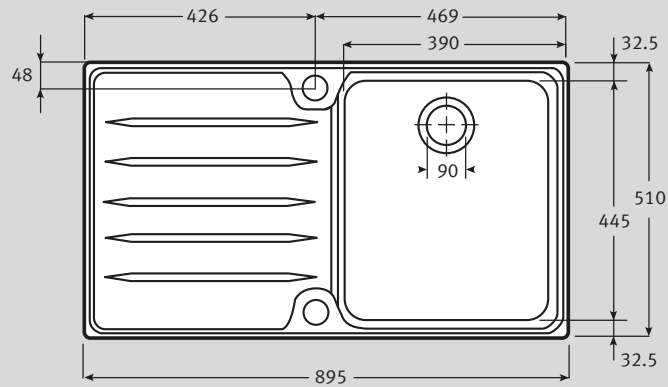

Material:	Stainless Steel
Application:	Inset
Bowl Size:	390 x 445 x 175
Drainer Format:	Left or right handed drainer available
Cut-out Size:	882 x 497 (cr=10) Always use a template
Colour:	Silk Finish Stainless Steel
Seal:	Apply locally
Insulation:	Grey Dynaphon for heat and sound
Heat Resistance:	Up to 300°C
Earthing Point:	N/A

Cabinet Size:

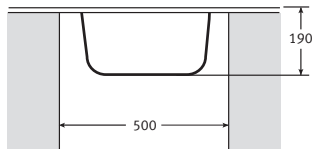

Fixing Clips: Patented Franke Slimfix® System

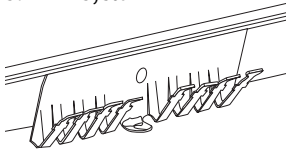

Suggested Plumbing Kit: Siphon 1

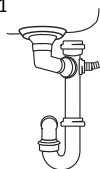

Waste: 1 x Lira 90mm Semi-Integrated Basket Strainer Waste with overflow

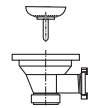

Overflow:

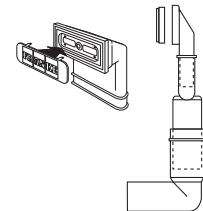

Accessories Available:

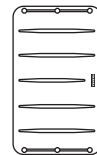

Sliding Glass Food Preparation Platter

Taps: Any Franke tap can be utilised with this model*.

*Ceramic disc taps in certain installations or where there is a low head of water (below 4 metres) may not provide adequate flow rates. You are advised to check with your supplier.

Some taps may need bracing to avoid flexing of the sink ledge.

Guarantee: Franke sinks are guaranteed for 50 years against manufacturing defect. Franke taps are guaranteed against defective materials and workmanship for 1 year in relation to coatings and finishes, and 5 years in relation to moving parts. Franke will replace (and where appropriate repair) defective sinks. In relation to taps, Franke will where appropriate provide replacement parts for your taps or replace your taps. Any associated or ancillary costs to be incurred by you as a result of replacement of Franke sinks and taps under this guarantee shall in all cases be previously approved by Franke UK Limited. This guarantee is in addition to and does not affect your statutory rights.